

Features

- 300 Watts peak pulse power ($t_p = 8/20\mu s$)
- Bidirectional and unidirectional configurations
- Solid-state silicon-avalanche technology
- Low clamping voltage
- Low leakage current
- Low capacitance ($C_j = 120$ pF typ.)
- Protection two data lines
- IEC 61000-4-2 ± 30 kV contact ± 30 kV air
- IEC 61000-4-4 (EFT) 40A(5/50ns)
- IEC 61000-4-5 (Lightning) 20A(8/20 μs)

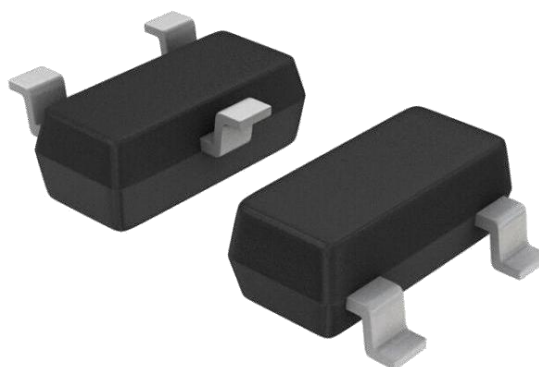

Applications

- Dataline
- Automatic Teller Machines
- Net works
- Power line

Mechanical Data

- SOT-23 package
- Molding compound flammability rating: UL 94V-0
- Packaging: Tape and Reel
- RoHS/WEEE Compliant

Schematic & PIN Configuration

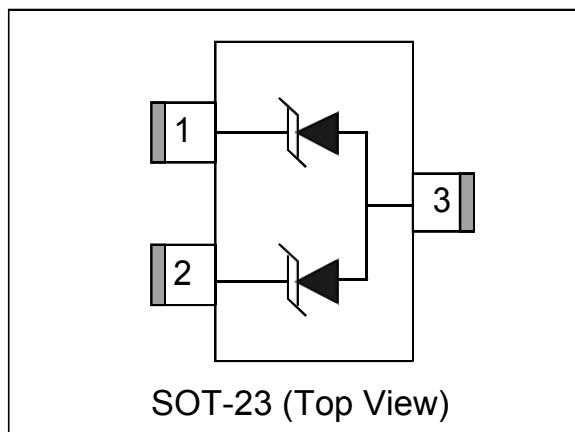
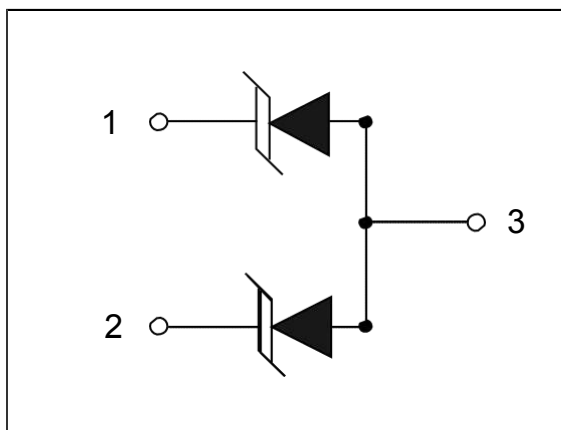

ESDT23A5V02V

Absolute Maximum Rating

Rating	Symbol	Value	Units
Peak Pulse Power ($t_p=8/20\mu s$)	P_{PP}	300	Watts
Peak Pulse Current ($t_p=8/20\mu s$)(note1)	I_{PP}	20	A
ESD per IEC 61000-4-2(Air) ESD per IEC 61000-4-2 (Contact)	V_{ESD}	30 30	kV
Lead Soldering Temperature	T_L	260(10seconds)	$^{\circ}C$
Junction Temperature	T_J	-55 to + 125	$^{\circ}C$
Storage Temperature	T_{stg}	-55 to + 125	$^{\circ}C$

Electrical Characteristics

Parameter	Symbol	Conditions	Min	Typical	Max	Units
Reverse Stand-Off Voltage	V_{RWM}				5	V
Reverse Breakdown Voltage	V_{BR}	$I_T=1mA$	6.0	7.0	8.5	V
Reverse Leakage Current	I_R	$V_{RWM}=5V, T=25^{\circ}C$		0.5	1	μA
Peak Pulse Current	I_{PP}	$t_p=8/20\mu s$			20	A
Clamping Voltage	V_C	$I_{PP}=10A, t_p=8/20\mu s$			12	V
		$I_{PP}=20A, t_p=8/20\mu s$			16	V
Junction Capacitance	C_j	$V_R=0V, f=1MHz$ (pin1、 pin2 to pin3)		120		pF

Electrical Parameters (TA = 25°C unless otherwise noted)

Symbol	Parameter
I_{PP}	Maximum Reverse Peak Pulse Current
V_C	Clamping Voltage @ I_{PP}
V_{RWM}	Working Peak Reverse Voltage
I_R	Maximum Reverse Leakage Current @ V_{RWM}
V_{BR}	Breakdown Voltage @ I_T
I_T	Test Current

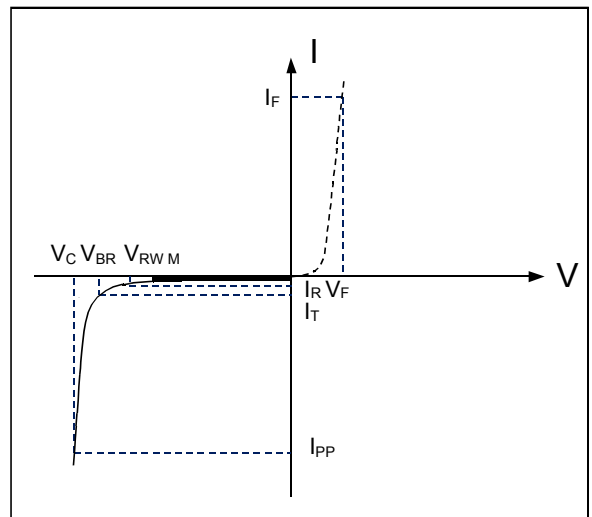

Note: 8/20 μs pulse waveform.

ESDT23A5V02V

Typical Characteristics

Figure 1: Peak Pulse Power vs. Pulse Time

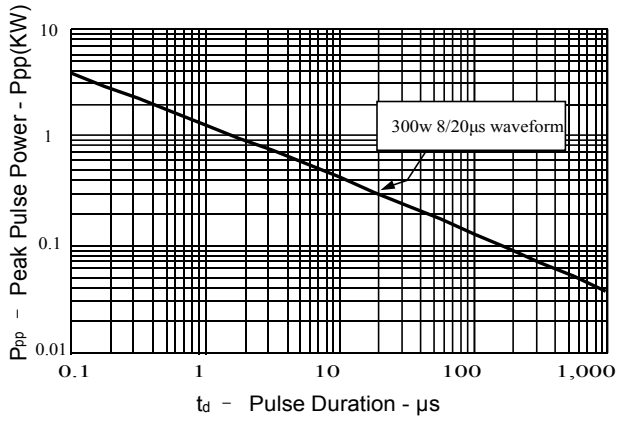

Figure 2: Power Derating Curve

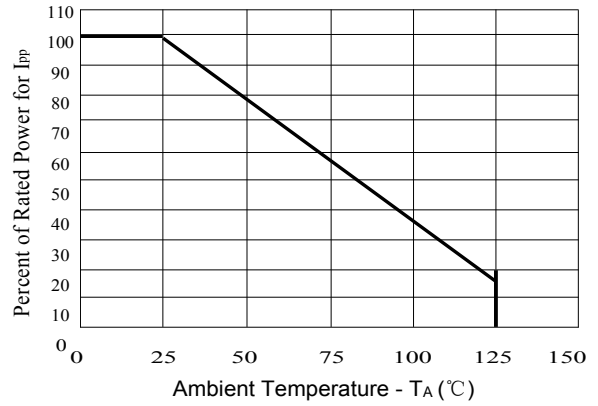

Figure 3: Pulse Waveform

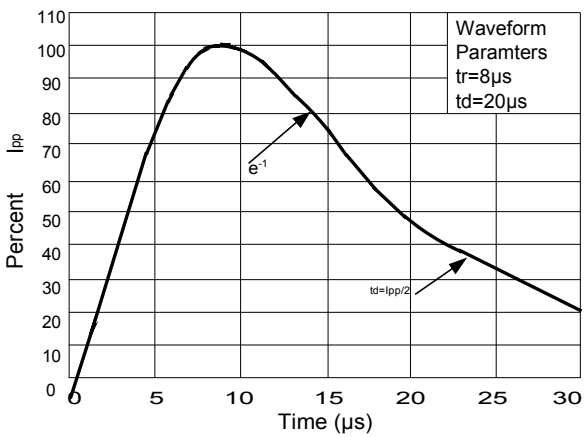
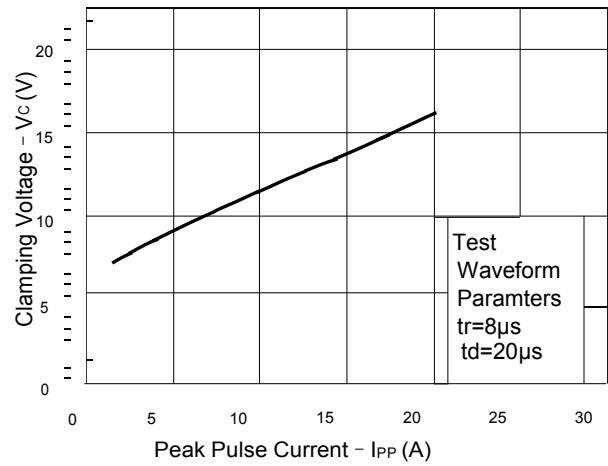
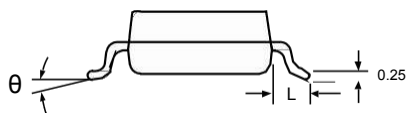
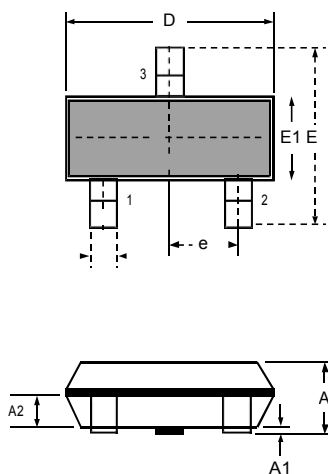

Figure 4: Clamping Voltage vs. I_{pp}



ESDT23A5V02V

Outline Drawing – SOT-23



DIMENSIONS

SYMBOL	MILLIMETER		INCHES	
	MIN	MAX	MIN	MAX
A	0.900	1.150	0.035	0.045
A1	0.000	0.100	0.000	0.004
A2	0.900	1.050	0.035	0.041
D	2.800	3.000	0.110	0.118
b	0.300	0.500	0.012	0.020
E	2.250	2.550	0.089	0.100
E1	1.200	1.400	0.047	0.055
e	0.950 BSC		0.037 BSC	
L	0.300	0.500	0.012	0.020
θ	0	8°	0	8°

Marking

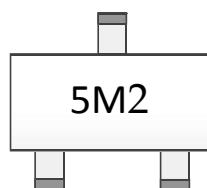

Ordering information

Order code	Package	Base qty	Delivery mode
ESDT23A5V02V	SOT-23	3k	Tape and reel