

Features

- Plastic package has Underwriters Laboratory Flammability Classification 94V-0
- Metal silicon junction ,majority carrier conduction
- Guard ring for overvoltage protection
- Low power loss ,high efficiency
- High current capability ,low forward voltage drop
- High surge capability
- High temperature soldering guaranteed:260°C/10 seconds at terminals
- Component in accordance to RoHS 2015/863/EU
- AEC-Q101 qualified and PPAP capable



AEC-Q101 Qualified

Mechanical Data

- Case: JEDEC SMA(DO-214AC) molded plastic body
- Terminals: Solder Plated, solderable per MIL-STD-750,method 2026
- Polarity: Color band denotes cathode end
- Weight: 0.002ounce, 0.064 gram
- Meets MSL 1 Requirements
- ESD Rating:MM:Class M4 ;HBM:Class 3B

SMA(DO-214AC)



Typical Applications

For use in low voltage ,high frequency inverters ,DC/DC converters, free wheeling ,and polarity protection applications

Marking:

JF:Logo
xxxx:Date code
SS34-V:Type

Maximum Ratings

(Ratings at 25°C ambient temperature unless otherwise specified)

Parameter	Symbol	Value	Unit
Maximum repetitive peak reverse voltage	V_{RRM}	40	V
Maximum average forward rectified current (see fig.1)	$I_{F(AV)}$	3.0	A
Peak forward surge current 8.3ms single half sine-wave superimposed on rated load (JEDEC method at rated TL)	I_{FSM}	80	A
Operating junction temperature range	T_J	-55 to+150	°C
Storage temperature range	T_{stg}	-55 to+150	°C

Electrical Characteristics (T_a=25°C Unless Otherwise Noted)

Parameter	Test Conditions		Symbol	Typ.	Max.	Unit
Instaneous forward voltage	T _J =25°C	I _F =1.0A	V _F ¹⁾	0.40	-	V
		I _F =3.0A		0.51	0.55	
	T _J =125°C	I _F =1.0A		0.30	-	
		I _F =3.0A		0.43	0.47	
Reverse current	T _J =25°C	V _R =40V	I _R ²⁾	-	100	μA
	T _J =125°C			-	15	mA
	T _J =125°C			V _R =32V	-	
Typical junction capacitance	4V,1MHz		C _J	160		pF

Notes: 1.Pulse test: 300 μs pulse width,1% duty cycle

2.Pulse test: pulse width≤40ms

Thermal Characteristics

Parameter	Symbol	SS34-V	Unit
Typical thermal resistance ³⁾	R _{θJA}	88.0	°C/W
	R _{θJL}	28.0	

3.Mounted with 1.0" x 1.0" (25.4 mm x 25.4 mm) copper pad areas 1 oz FR4 Board

Available Pack Information

Product code	Pack	Reel Size (mm)	Quantity (pcs/reel)	Box Size L×W×H (mm)	Quantity (reel/box)	Carton Size L×W×H (mm)	Quantity (box/carton)
SS34-V-SMA	T/R	Φ330	7500	330×35×333	2	364×364×360	8

Fig.1-Forward Current Derating Curve

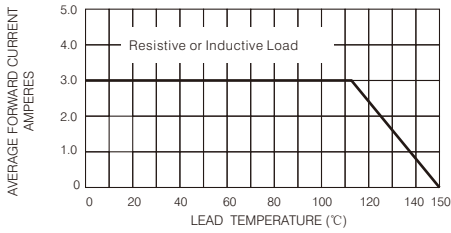

Fig.2-Maximum Non-repetitive Peak Forward Surge Current

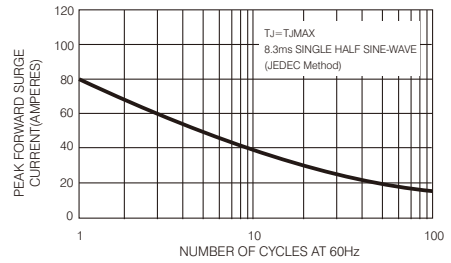

Fig.3-Typical Instantaneous Forward Characteristics

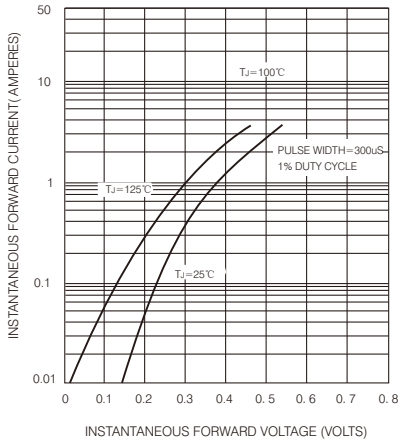

Fig.4-Typical Reverse Characteristics

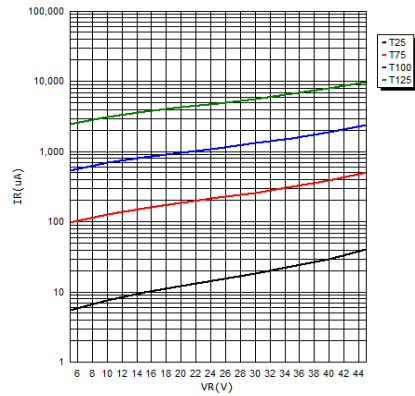
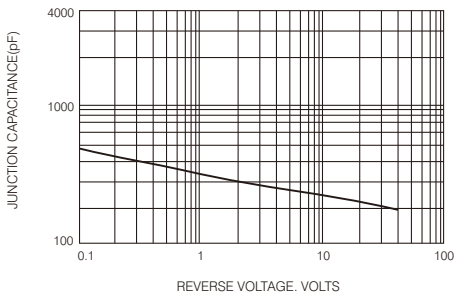
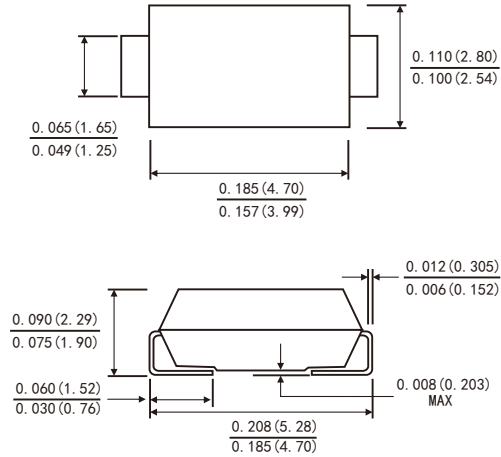

Fig.5-TYPICAL JUNCTION CAPACITANCE



SMA(DO-214AC)



Suggested PAD Layout

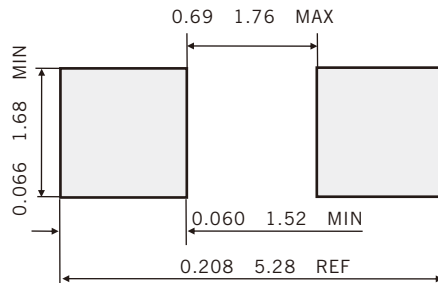

Dimensions in inches and (millimeters)

Friendship Reminder

- JiNan JingHeng(hereinafter referred to as JH) reserves the right to make changes to this document and its products and specifications at anytime without notice.
- Customers should obtain and confirm the latest product information and specifications before final design, purchase or use.
- JH makes no warranty, representation or guarantee regarding the suitability of its products for any particular purpose, nor does JH assume any liability for application assistance or customer product design.
- JH does not warrant or accept any liability with products which are purchased or used for any unintended or unauthorized application.
- No license is granted by implication or otherwise under any intellectual property rights of JH.
- JH's products are not authorized for use as critical components in life support devices or systems without express written approval of JH.