

### FEATURES

- Very low profile package
- Ideal for automated placement
- Metal silicon junction ,majority carrier conduction
- Guard ring for overvoltage protection
- Low power loss ,high efficiency
- High current capability ,low forward voltage drop
- High surge capability
- Per J-STD-020,LF maximum peak of 260°C
- Component in accordance to RoHS 2015/65/EU
- AEC-Q101 qualified and PPAP capable



**AEC-Q101 Qualified**

### MECHANICAL DATA

- Case: Flat lead SOD-123FL small outline plastic package
- Molding compound meets UL 94 V-0 flammability rating
- Terminals: solderable per J-STD-002 and JESD22-B102
- Polarity: color band denotes cathode end
- Mounting Position: Any
- Weight: 8.85 mg(approximately)



Primary Characteristics	
$I_F(AV)$	1.0A
$V_{RRM}$	60V
$I_{FSM}$	40A
$V_f$ at $I_f=1.0A(125^\circ C)$	0.41V
$I_{R(Max)}$	30 $\mu$ A
$T_J(Max)$	150°C
Package	SOD-123FL

### TYPICAL APPLICATIONS

For use in low voltage ,high frequency inverters ,DC/DC converters, free wheeling ,and polarity protection applications

### MAXIMUM RATINGS

(Ratings at 25°C ambient temperature unless otherwise specified )

Parameter	Symbol	Value	Unit
Maximum repetitive peak reverse voltage	$V_{RRM}$	60	V
Maximum average forward rectified current (see fig.1)	$I_F(AV)$	1.0	A
Peak forward surge current 8.3ms single half sine-wave superimposed on rated load (JEDEC method at rated TL)	$I_{FSM}$	40	A
Operating junction temperature range	$T_J$	-55 to+150	°C
Storage temperature range	$T_{stg}$	-55 to+150	°C

## ELECTRICAL CHARACTERISTICS (T<sub>A</sub>=25°C Unless otherwise noted)

Parameter	Test Conditions		Symbol	Typ.	Max.	Unit
Instantaneous forward voltage	I <sub>F</sub> =1.0A	T <sub>J</sub> =25°C	V <sub>F</sub> <sup>1)</sup>	0.47	0.52	V
		T <sub>J</sub> =100°C		0.43	0.48	
		T <sub>J</sub> =125°C		0.41	0.46	
Reverse current	V <sub>R</sub> =60V	T <sub>J</sub> =25°C	I <sub>R</sub> <sup>2)</sup>	8.0	30	μA
		T <sub>J</sub> =100°C		-	5.0	mA
		T <sub>J</sub> =125°C		-	23	
Typical junction capacitance	4V,1MHz		C <sub>J</sub>	78		pF

Notes: 1.Pulse test: 300 μs pulse width,1% duty cycle

2.Pulse test: pulse width≤40ms

## THERMAL CHARACTERISTICS

Parameter	Symbol	L16-V	Unit
Typical thermal resistance <sup>3)</sup>	Junction to Ambient R <sub>θJA</sub>	82	°C/W
	Junction to Lead R <sub>θJL</sub>	26	

3.Mounted on 1 inch square pad size (1 x 0.5 inch for each lead) on FR4 board. The heat generated must be less than the thermal conductivity from junction-to-ambient: dP<sub>J</sub>/dT<sub>J</sub> < 1/R<sub>θJA</sub>

## AVAILABLE PACK INFORMATION

Product code	Pack	Reel Size (mm)	Quantity (pcs/reel)	Box Size L×W×H (mm)	Quantity (reel/box)	Carton Size L×W×H (mm)	Quantity (box/carton)
L16-V-SOD-123FL	T/R	Φ330	7500	330×35×333	2	364×364×360	8

# RATINGS AND CHARACTERISTIC OF L16-V

FIG.1-FORWARD CURRENT DERATING CURVE

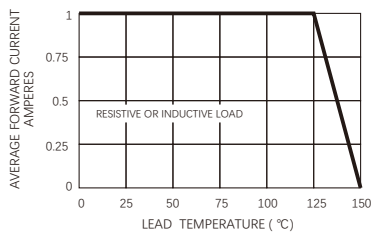

FIG.2-MAXIMUM NON-REPETITIVE PEAK FORWARD SURGE CURRENT

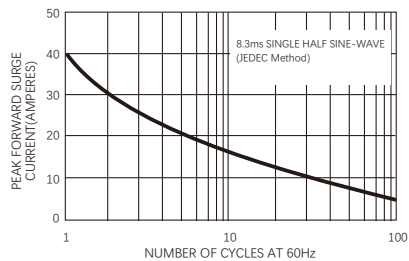

FIG.3-TYPICAL INSTANTANEOUS FORWARD CHARACTERISTICS

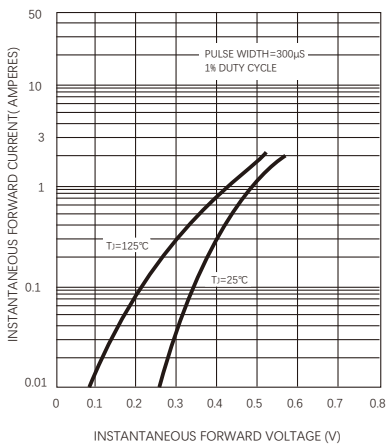

FIG.4-TYPICAL REVERSE CHARACTERISTICS

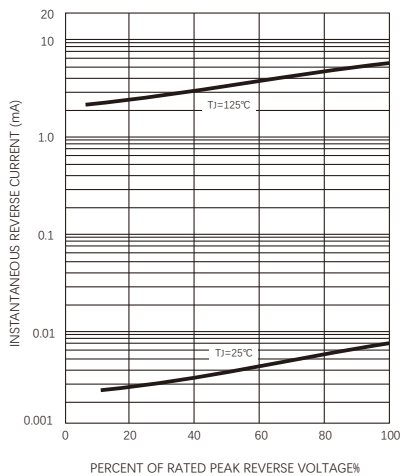
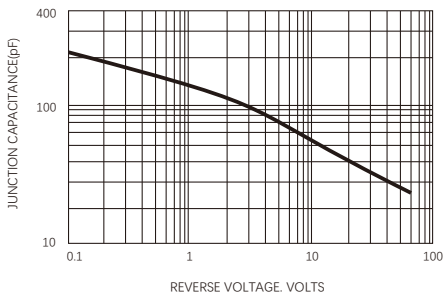
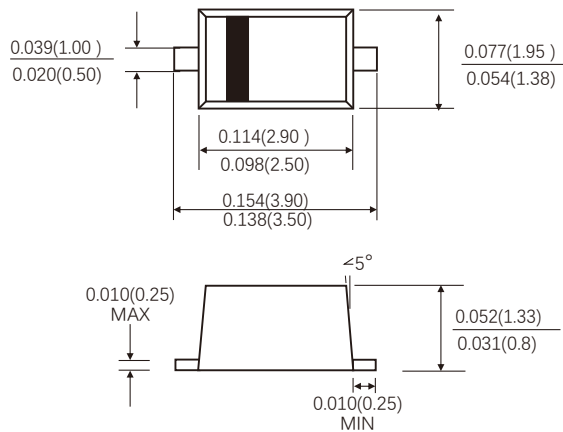

FIG.5-TYPICAL JUNCTION CAPACITANCE



SOD-123FL



Suggested PAD Layout

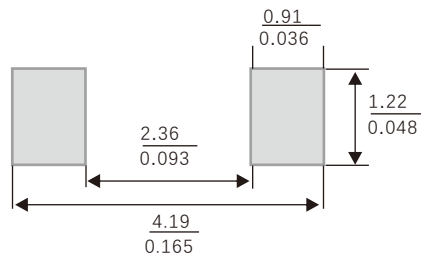

Dimensions in millimeters/inches

## Friendship Reminder

- JiNan JingHeng (hereinafter referred to as JH) reserves the right to make changes to this document and its products and specifications at anytime without notice.
- Customers should obtain and confirm the latest product information and specifications before final design, purchase or use.
- JH makes no warranty, representation or guarantee regarding the suitability of its products for any particular purpose, nor does JH assume any liability for application assistance or customer product design.
- JH does not warrant or accept any liability with products which are purchased or used for any unintended or unauthorized application.
- No license is granted by implication or otherwise under any intellectual property rights of JH.
- JH's products are not authorized for use as critical components in life support devices or systems without express written approval of JH.