

FEATURES

- Plastic package has Underwriters Laboratory Flammability Classification 94V-0
- Metal silicon junction ,majority carrier conduction
- Guard ring for overvoltage protection
- Low power loss ,high efficiency
- High current capability ,low forward voltage drop
- High surge capability
- High temperature soldering guaranteed:260°C/10 seconds at terminals
- Component in accordance to RoHS 2015/863/EU



MECHANICAL DATA

- Case: SMAF molded plastic body
- Terminals: Solder Plated, solderable per MIL-STD-750,method 2026
- Polarity: Color band denotes cathode end

SMAF

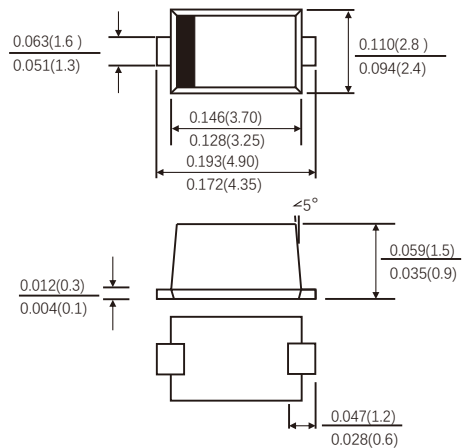

Suggested PAD Layout

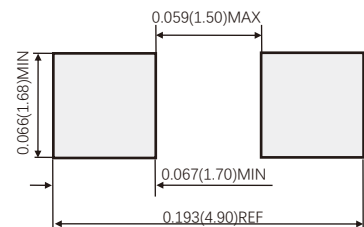

Dimensions in inches and (millimeters)

TYPICAL APPLICATIONS

For use in low voltage ,high frequency inverters ,DC/DC converters, free wheeling ,and polarity protection applications

MAXIMUM RATINGS

(Ratings at 25°C ambient temperature unless otherwise specified)

Parameter	Symbol	Value	Unit
Maximum repetitive peak reverse voltage	V _{RRM}	60	V
Maximum average forward rectified current (see fig.1)	I _{F(AV)}	1.0	A
Peak forward surge current 8.3ms single half sine-wave superimposed on rated load (JEDEC method at rated TL)	I _{FSM}	40	A
Operating junction temperature range	T _j	-55 to+150	°C
Storage temperature range	T _{stg}	-55 to+150	°C

ELECTRICAL CHARACTERISTICS (T_A=25°C Unless otherwise noted)

Parameter	Test Conditions		Symbol	Typ.	Max.	Unit
Instantaneous forward voltage	I _F =1.0A	T _J =25°C	V _F ¹⁾	0.47	0.52	V
		T _J =100°C		0.43	0.48	
		T _J =125°C		0.41	0.46	
Reverse current	V _R =60V	T _J =25°C	I _R ²⁾	-	100	μA
		T _J =100°C		-	5	mA
		T _J =125°C		-	20	
Typical junction capacitance	4V,1MHz		C _J	78		pF

Notes: 1.Pulse test: 300 μs pulse width,1% duty cycle

2.Pulse test: pulse width ≤40ms

THERMAL CHARACTERISTICS

Parameter	Symbol	SMAF	Unit
Typical thermal resistance	R _{θJA} ^{3) 4)}	150	°C/W
	R _{θJM} ⁵⁾	15	

3.The heat generated must be less than the thermal conductivity from junction-to-ambient: $dP_c/dT_j < 1/R_{\theta JA}$

4.Thermal resistance junction-to-ambient to follow JEDEC51-2A, device mounted on FR4 PCB, 2 oz., standard footprint

5.Thermal resistance junction-to-mount to follow JEDEC51-14 transient dual interface test method (TDIM)

AVAILABLE PACK INFORMATION

Product code	Pack	Reel Size (mm)	Quantity (pcs/reel)	Box Size L×W×H (mm)	Quantity (reel/box)	Carton Size L×W×H (mm)	Quantity (box/carton)	Quantity(carton) (K)
SS16LS-SMAF	T/R	Φ178	3000	180×180×105	6	550×200×205	5	90

RATINGS AND CHARACTERISTIC OF SS16LS

FIG.1-FORWARD CURRENT DERATING CURVE

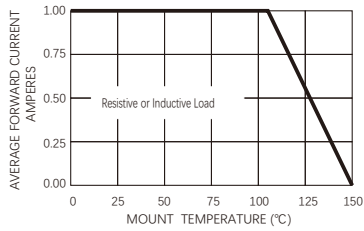

FIG.2-MAXIMUM NON-REPETITIVE PEAK FORWARD SURGE CURRENT

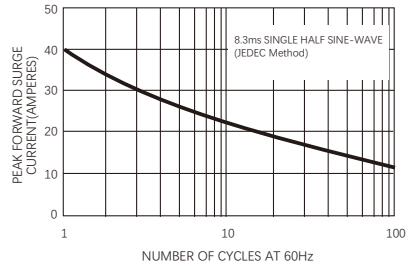

FIG.3-TYPICAL INSTANTANEOUS FORWARD CHARACTERISTICS

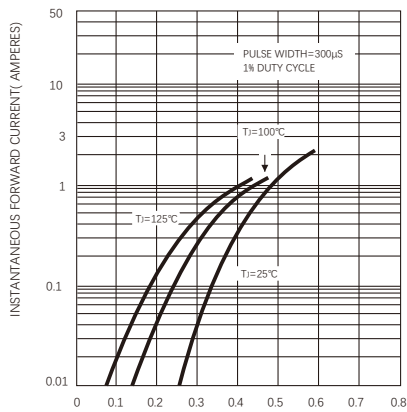

FIG.5-TYPICAL JUNCTION CAPACITANCE

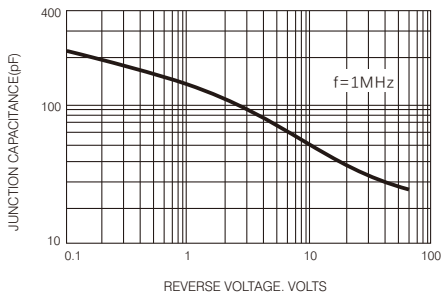
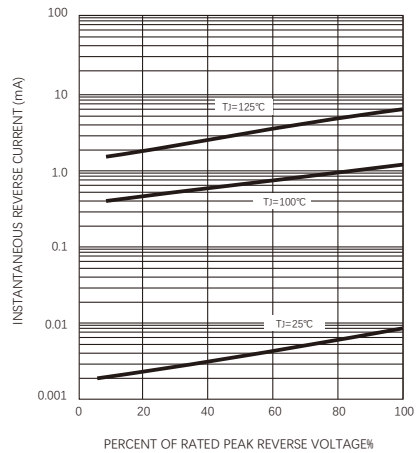

FIG.4-TYPICAL REVERSE CHARACTERISTICS



Friendship Reminder

- JiNan JingHeng (hereinafter referred to as JH) reserves the right to make changes to this document and its products and specifications at anytime without notice.
- Customers should obtain and confirm the latest product information and specifications before final design, purchase or use.
- JH makes no warranty, representation or guarantee regarding the suitability of its products for any particular purpose, nor does JH assume any liability for application assistance or customer product design.
- JH does not warrant or accept any liability with products which are purchased or used for any unintended or unauthorized application.
- No license is granted by implication or otherwise under any intellectual property rights of JH.
- JH's products are not authorized for use as critical components in life support devices or systems without express written approval of JH.